

0402 Package SMD LED 0.5mm Height

VS 16D8

Description

The major breakthrough in VS 16D8 Yellow color emitted, is package in dimension L x W x H, 1.0 * 0.5 * 0.5 mm. The dice used in this series is AlGaInP material rather than the conventional GaP and GaAsP/GaP. The advantages of AlGaInP are low power consumption and obtaining high luminous intensity under low current driving condition. The wavelengths and luminous intensities of this series are grouped under 20mA for uniformity. These LED are suitable for multiple usages in series connection applications.



Applications

- Cellular phone display
- Backlight keypads
- Industrial control systems signal indicator
- Automotive features



Electronic Optical Characteristics (at 20mA):

Part Number	Emitted Color	λ (nm)		Lens Color	Iv(mcd)		View Angle	VF(V)	
		λ_d	λ_p		Min.	Typ.		Typ.	Max.
VS 16D8	Yellow 	589	591	Clear	22.4	45	120	2.0	2.4

Absolute Maximum Ratings (at Ta=25°C)

P _D (mW)	I _{FP} (mA)	I _F (mA)	Iron Solder (°C)	I _R (μ A)@V _R =5V	Topr(°C)	Tstg(°C)
60	100*	25	350 \pm 5 for 3 sec.	10	-40~+85	-40~+100

Note: Please take note the Absolute Maximum Rating values. Any operation beyond the specify ratings in this table will result degradation of LED life-span and may cause LED to fail.

* I_{FP}: Peak Forward Current under 1/10 duty, 1KHz condition

Package Dimension:

unit:mm

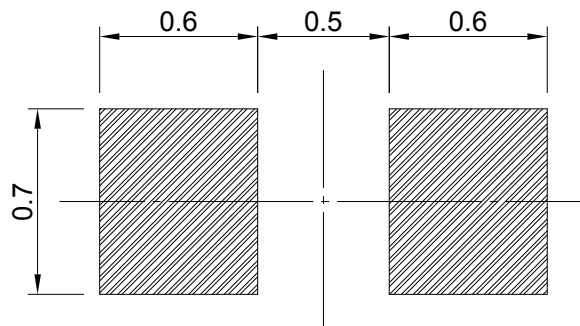
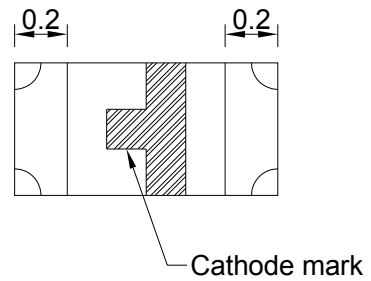
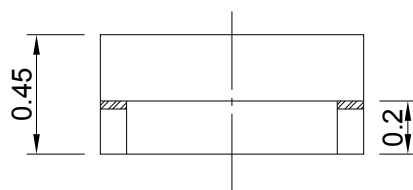
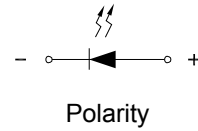
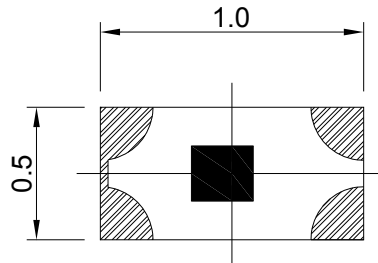

Recommended Soldering Pad

Notes:

1. All dimensions are millimeters.
2. Tolerance is ± 0.2 mm unless otherwise specified.
3. Specifications are subject to change without notice.

Optical Characteristics Curves

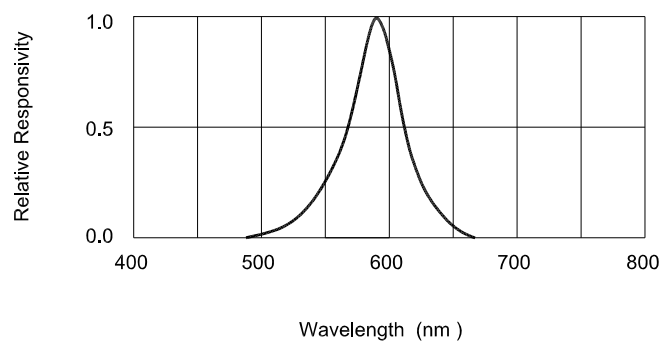
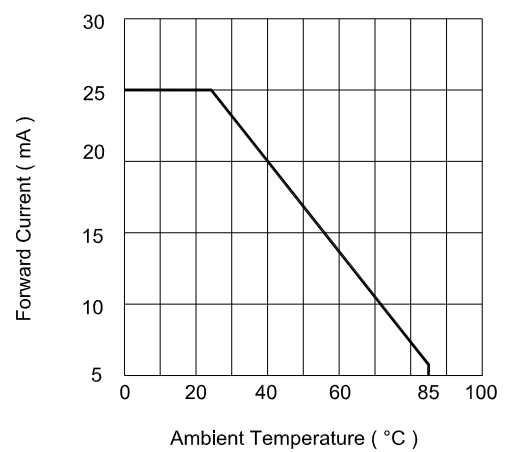
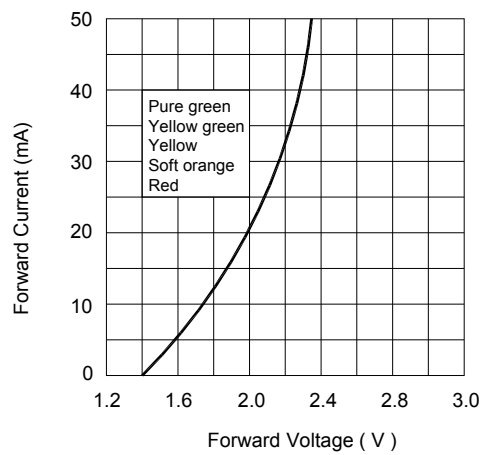
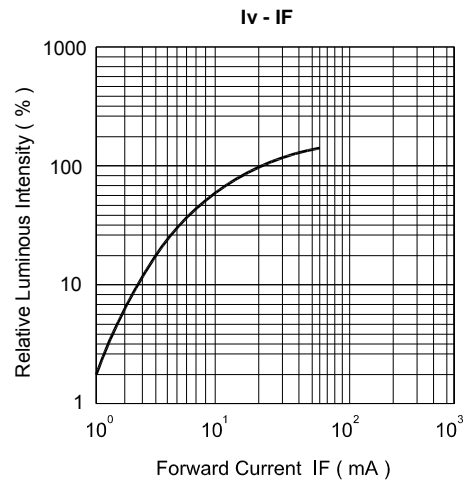
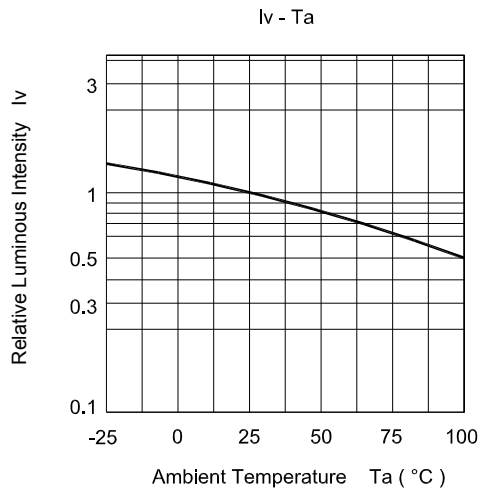

Reel Dimension:

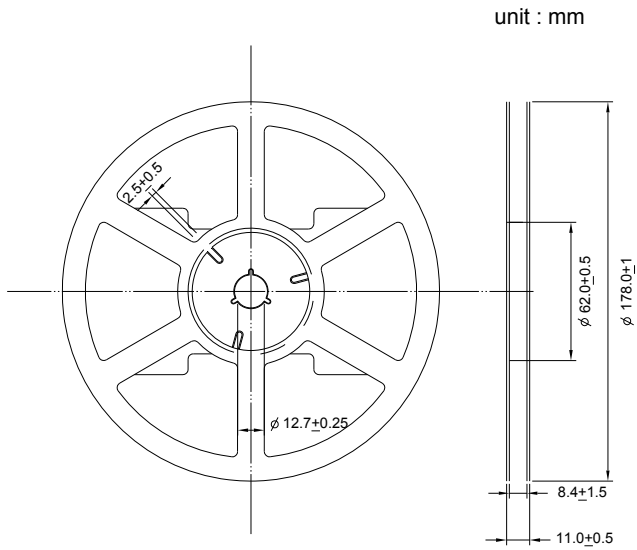

Note:

Available in 8mm carrier tape on 178mm diameter reels. (3,000 pieces)

Tape Dimension:

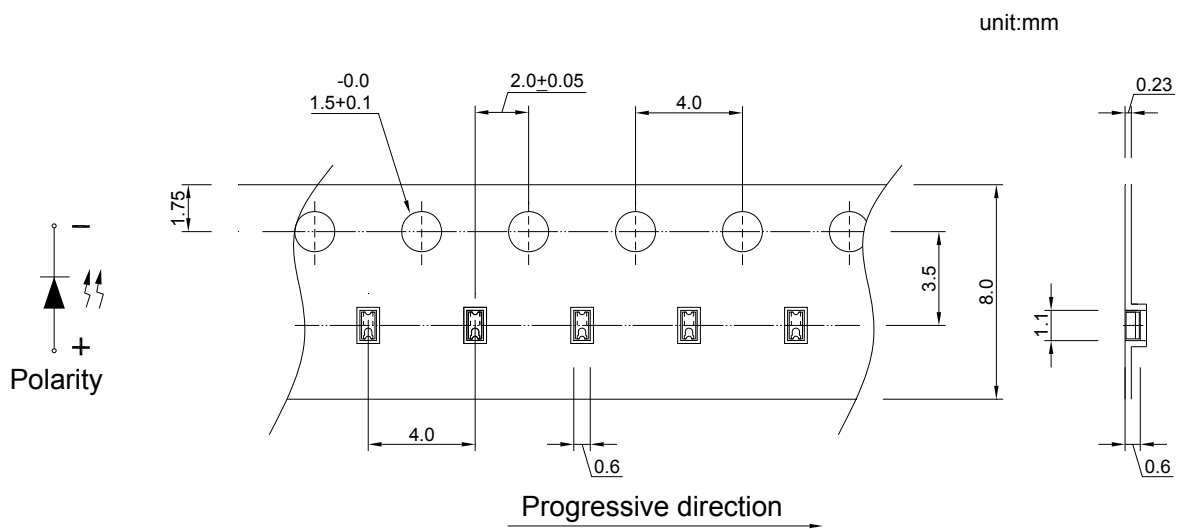

Recommended re-flow soldering profile:

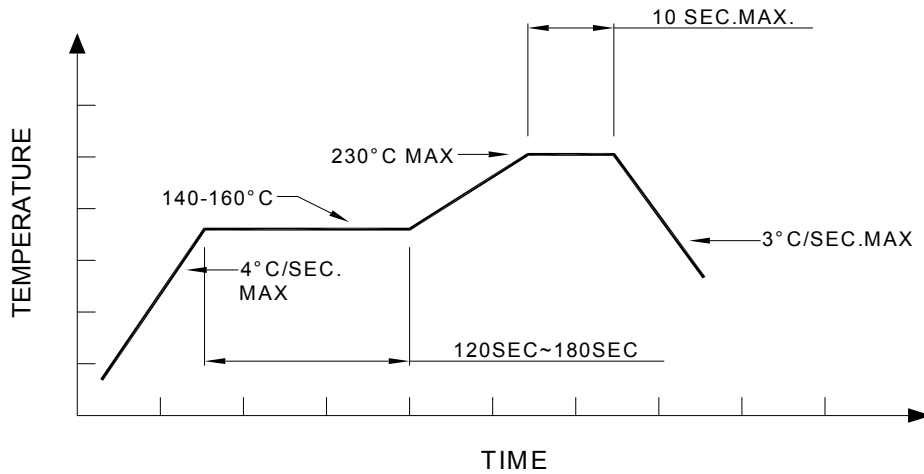

Recommended Pb-free re-flow soldering profile:

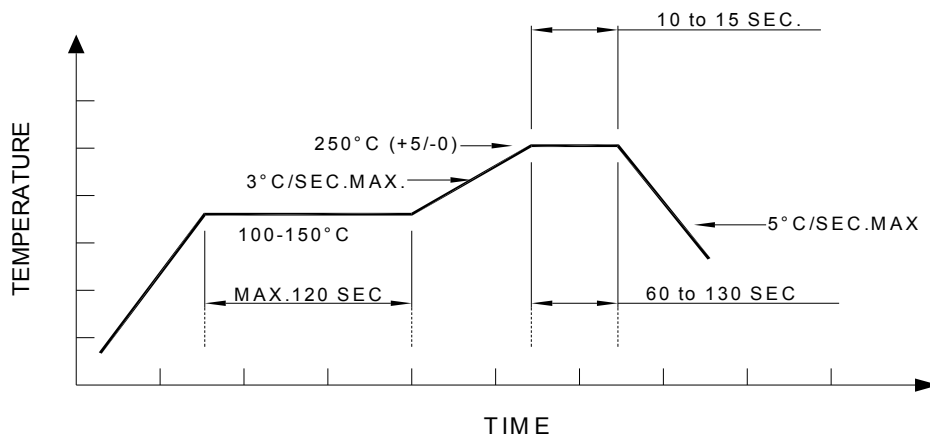

Note:

All the specifications listed in this data sheet are suitable for general electronic equipment, office equipment and communication devices. Kindly consult Sales Representatives for specific reliabilities request, Forward Voltage, Luminous Intensity, Wavelength, Radiant Power or Viewing Angle.